

LÄGENHET 11-1002
ca 55 kvm

LÄGENHET 11-1001
ca 48 kvm

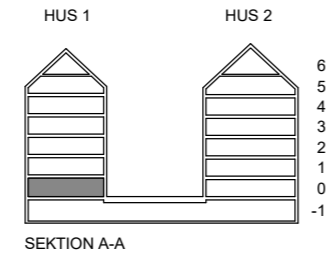

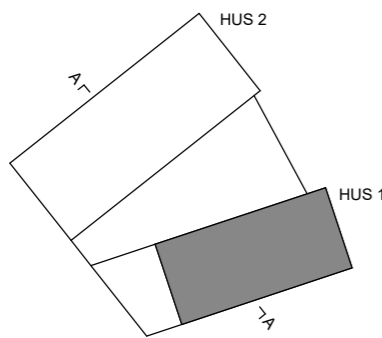

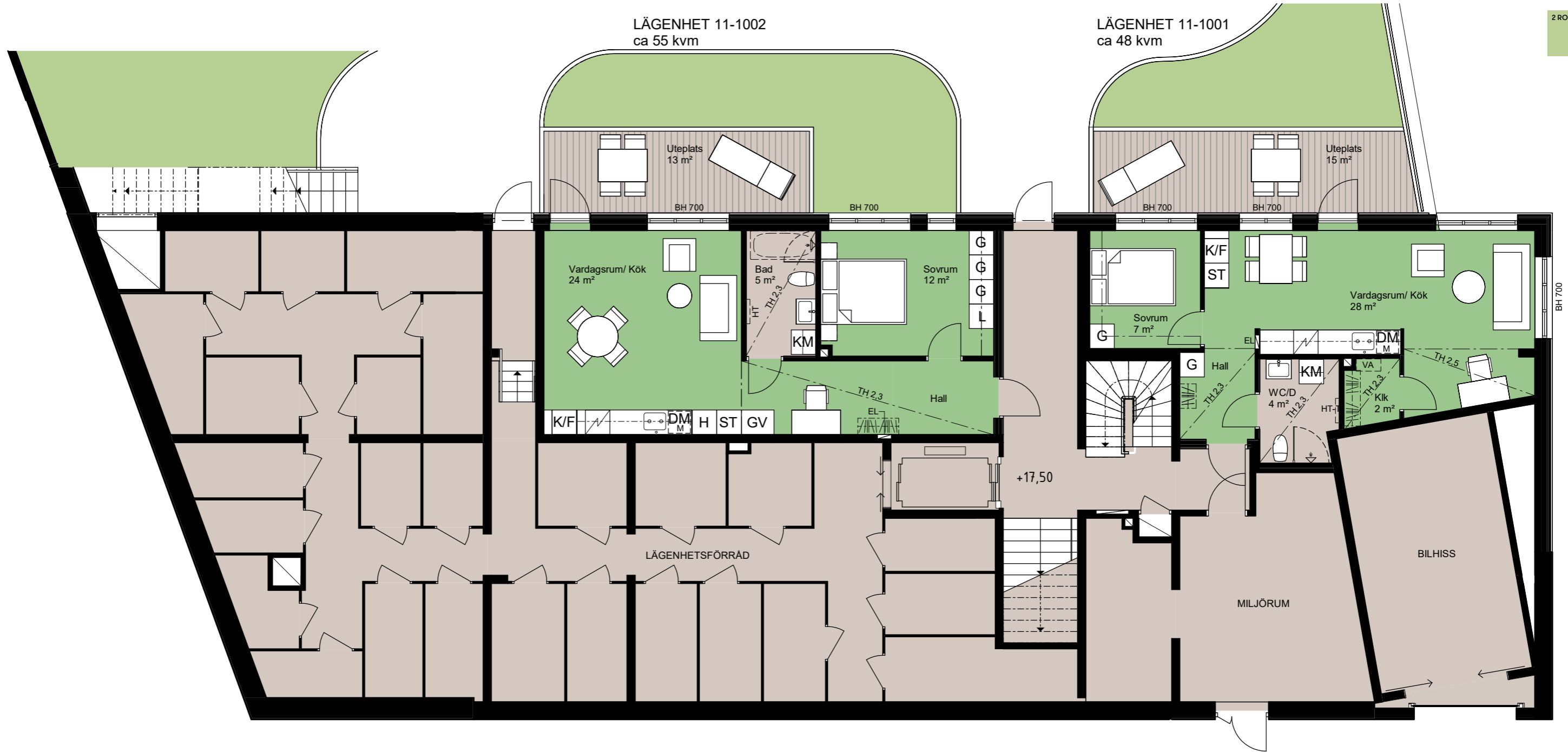
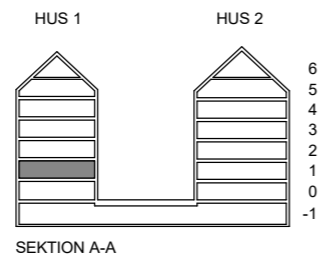
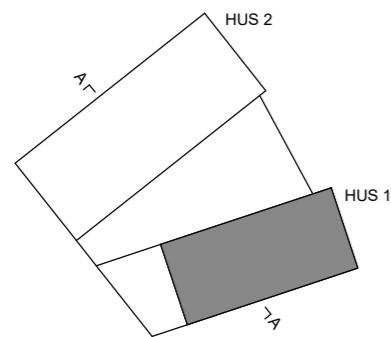
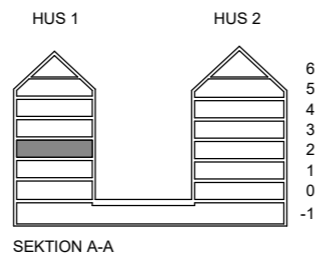
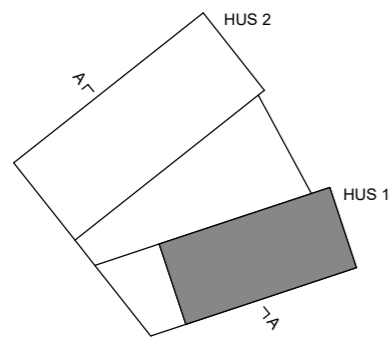

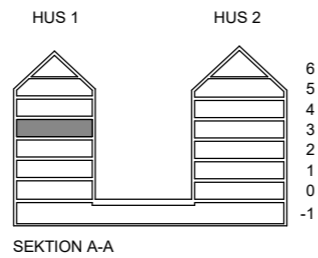
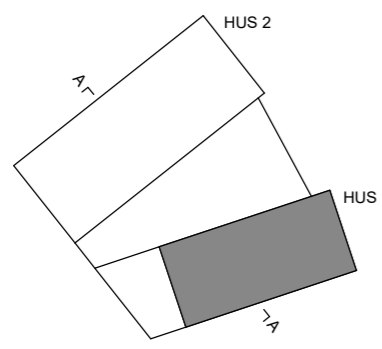
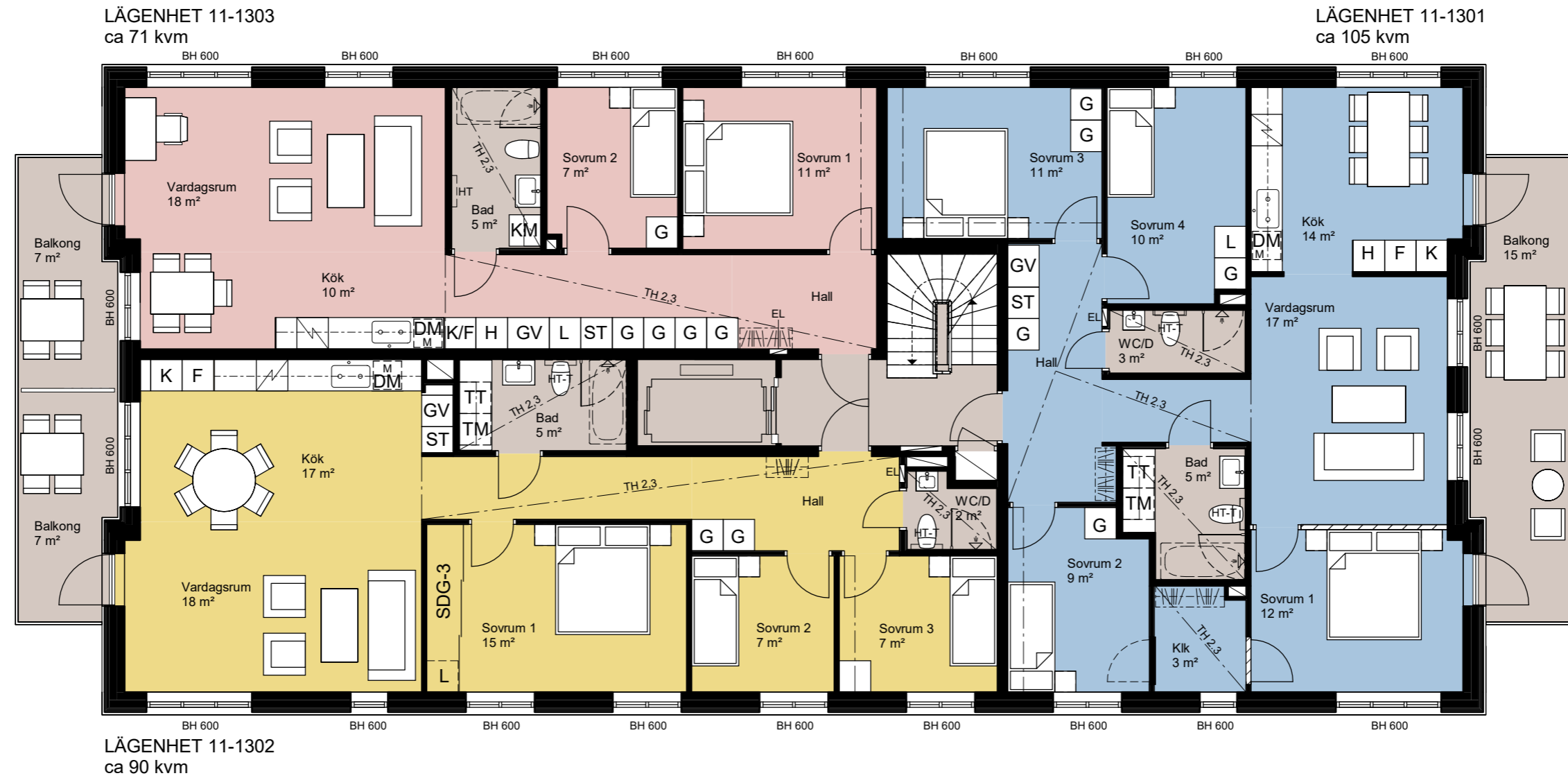

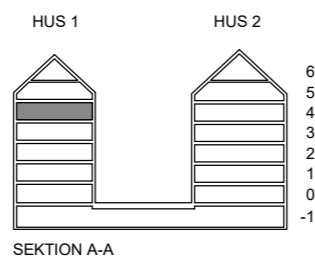
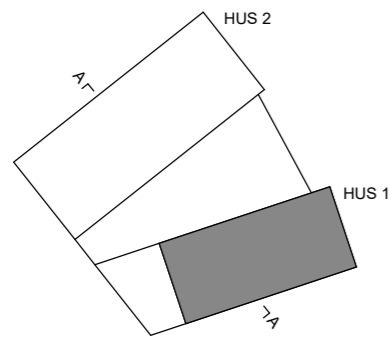
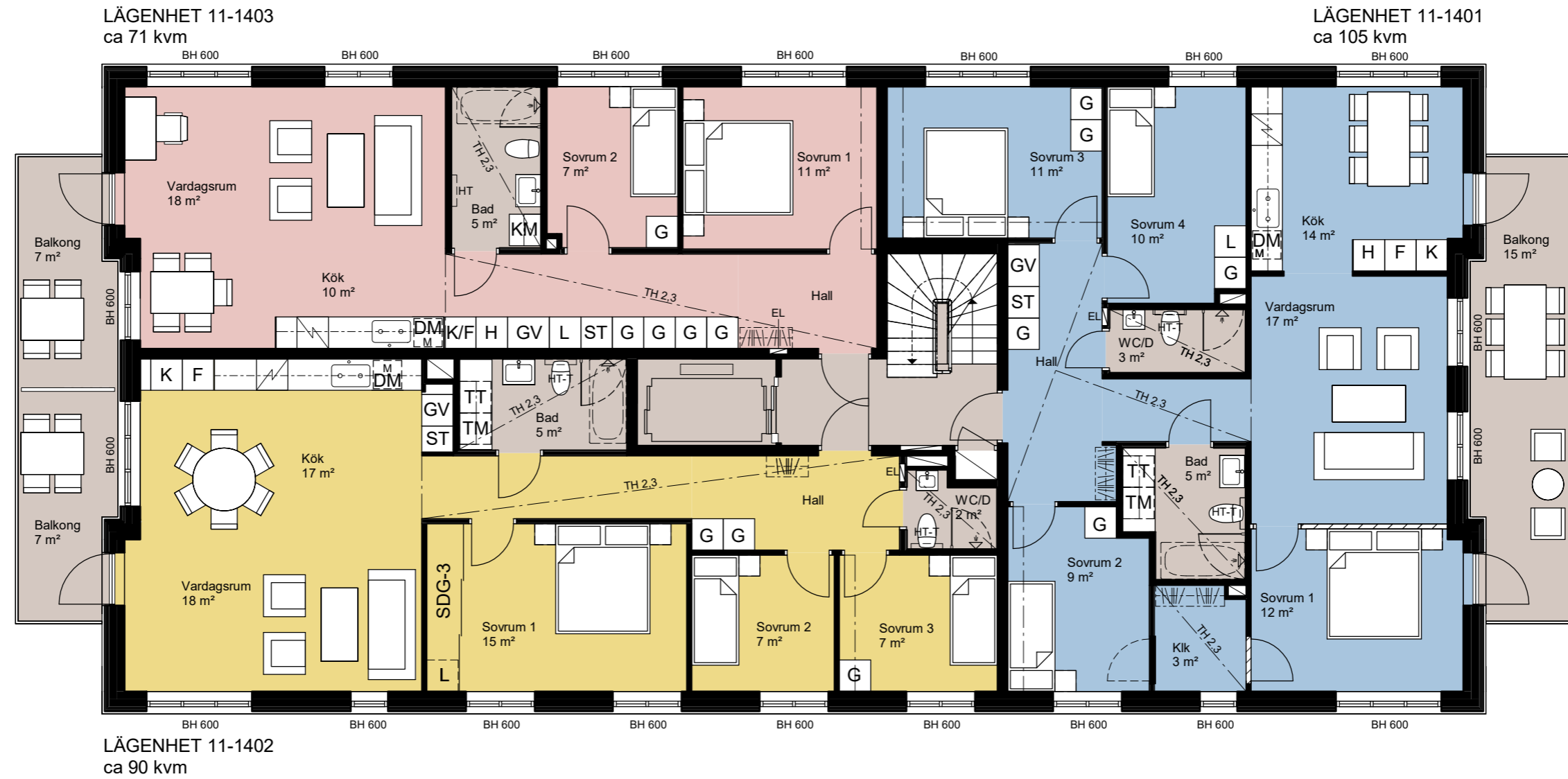

SKALA 1:100

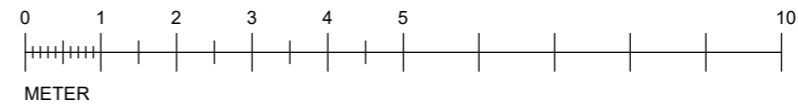



LÄGENHET 11-1502
ca 125 kvm

YTA RÄKNAS EJ I BOA
& RUMSAREA: ca 9 m²

YTA RÄKNAS EJ I BOA
& RUMSAREA: ca 5 m²

LÄGENHET 11-1501
ca 93 kvm

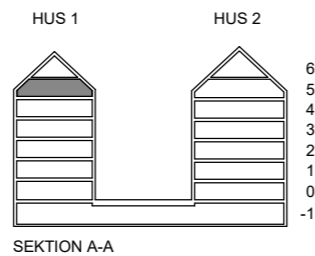
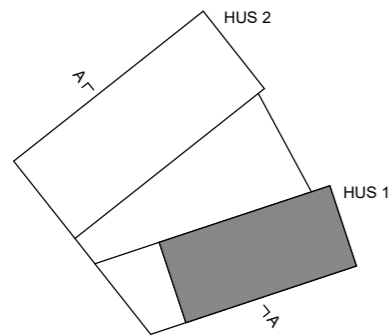
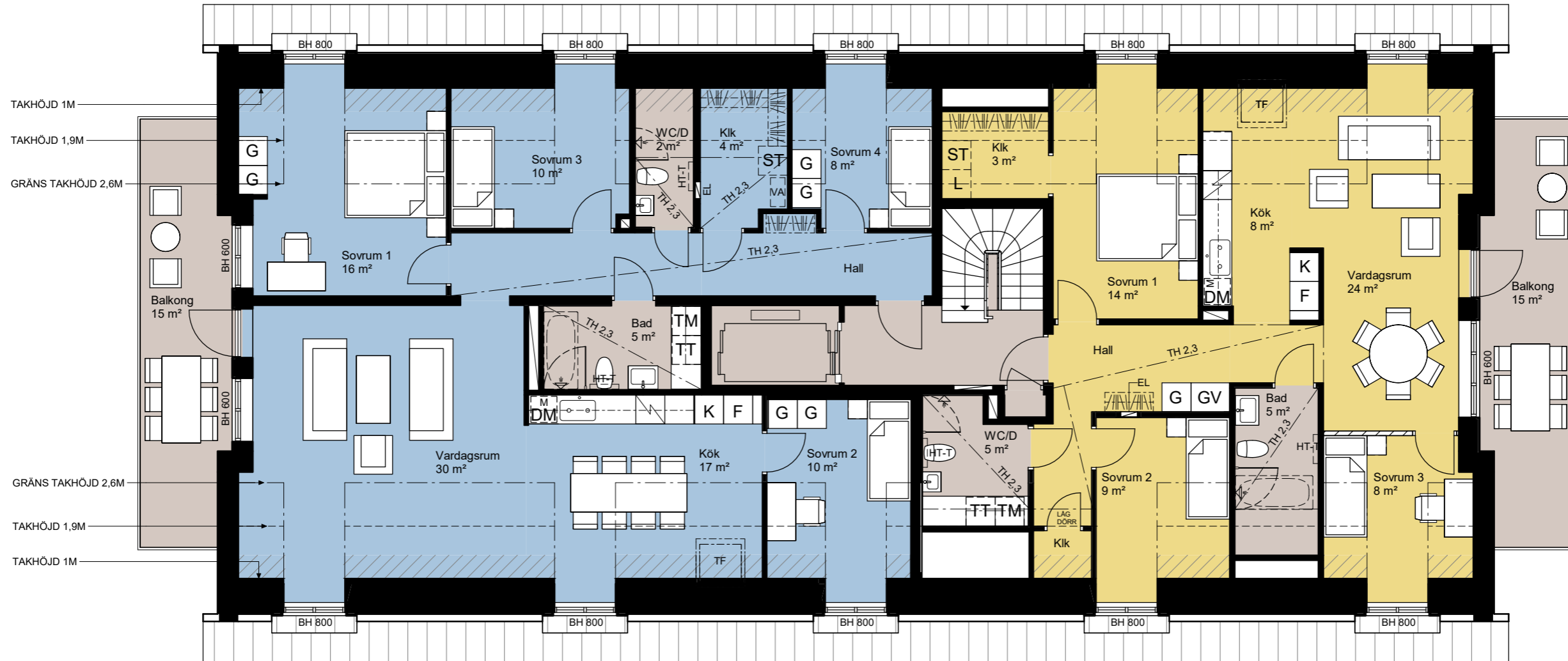

SKALA 1:100



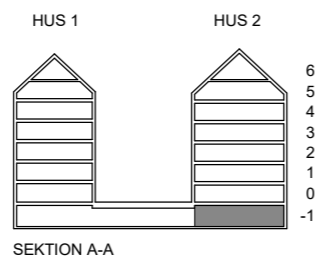
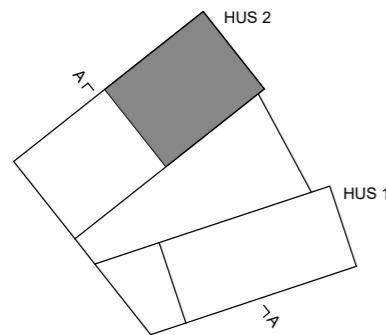

SKALA 1:100

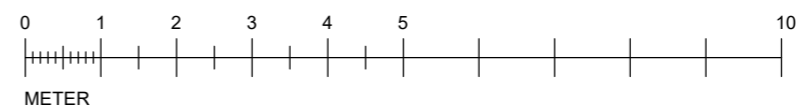

Hus 2

Entréplan

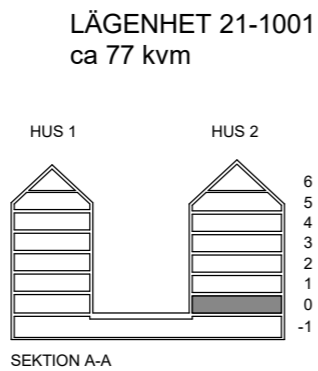
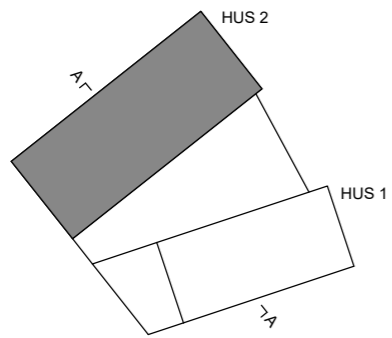
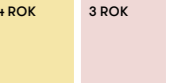

LÄGENHET 21-1004
ca 89 kvm



Rätt till ändringar förbehålles. Ytångivelser är preliminära. Rumsytor är avrundade till närmaste heltal. Originalformat A3. Rev.2023-09-14

Hus 2

Plan 1



LÄGENHET 21-1105
ca 104 kvm

LÄGENHET 21-1106
ca 42 kvm

LÄGENHET 21-1101
ca 104 kvm

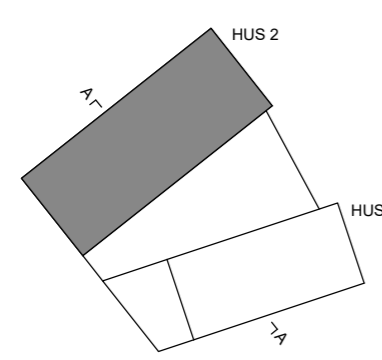
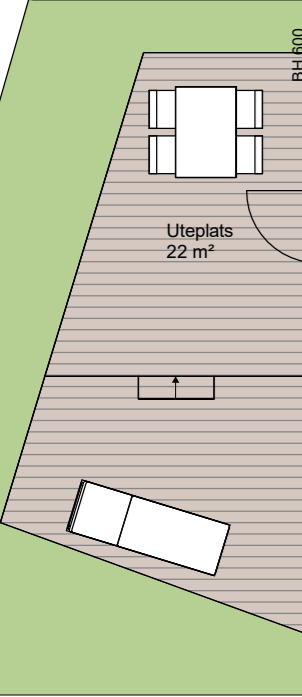

LÄGENHET 21-1104
ca 72 kvm

LÄGENHET 21-1103
ca 46 kvm

LÄGENHET 21-1102
ca 74 kvm

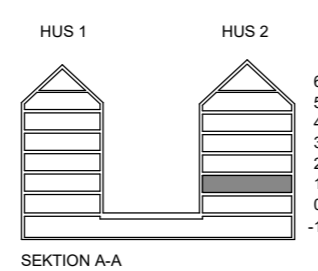

Witte Sundell



LÄGENHET 21-1205
ca 77 kvm

LÄGENHET 21-1206
ca 42 kvm

LÄGENHET 21-1201
ca 104 kvm

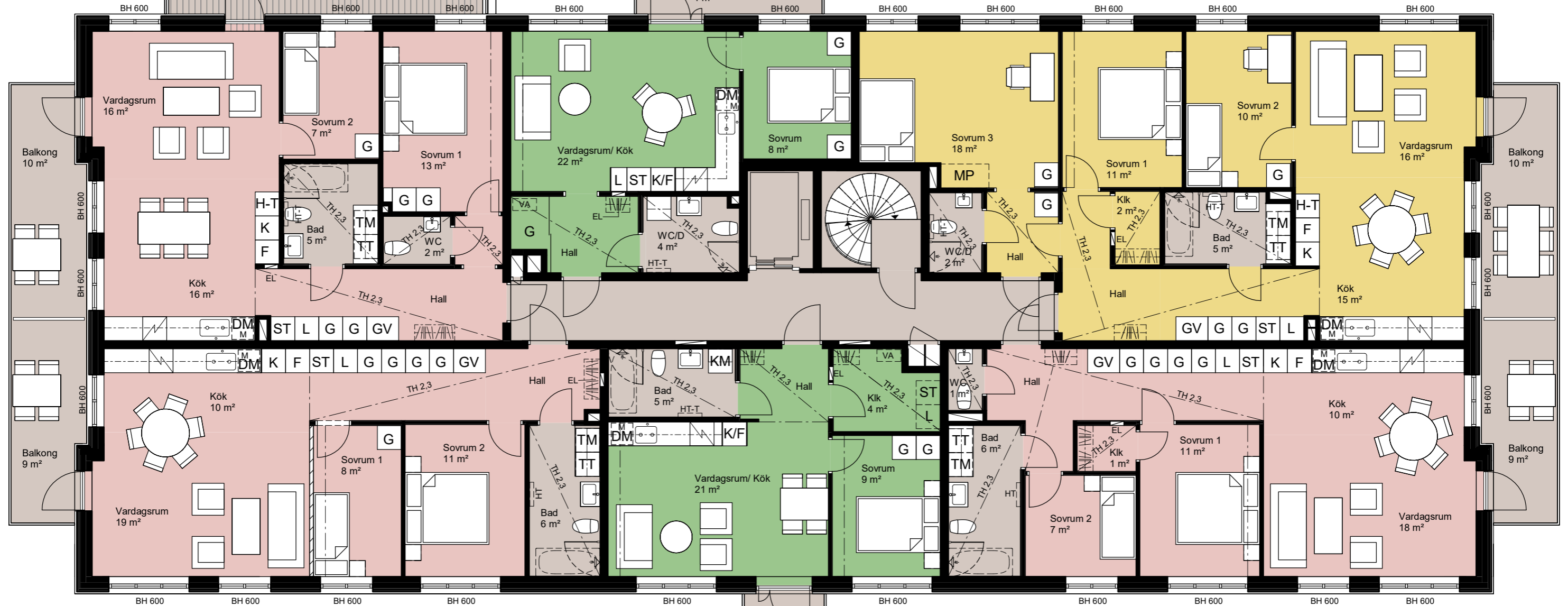

LÄGENHET 21-1204
ca 71 kvm

LÄGENHET 21-1203
ca 46 kvm

LÄGENHET 21-1202
ca 74 kvm

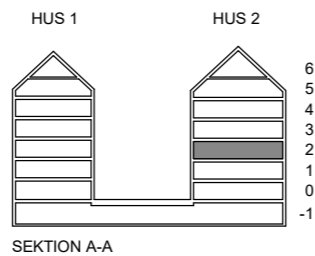
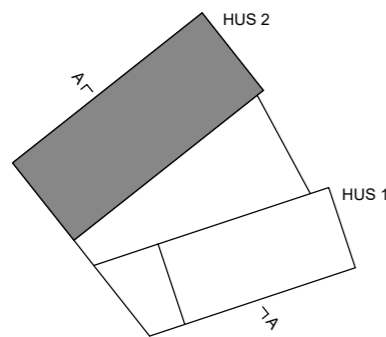

SKALA 1:100

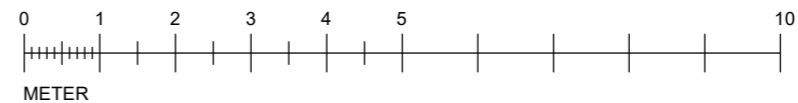

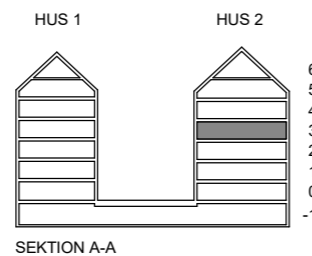
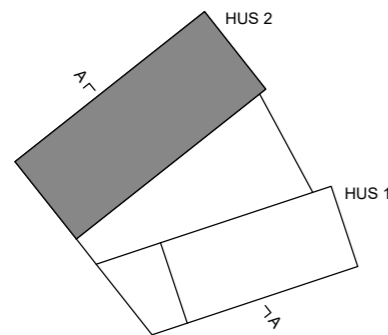

SKALA 1:100

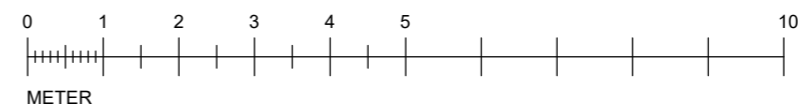

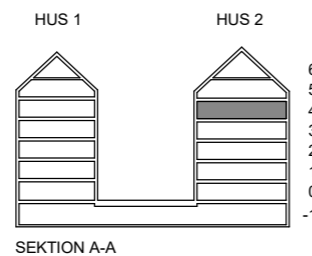
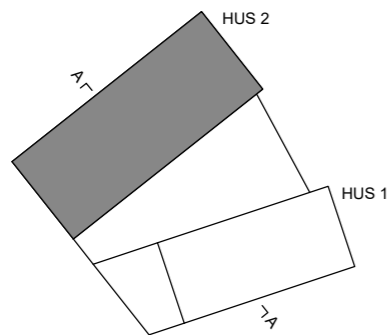
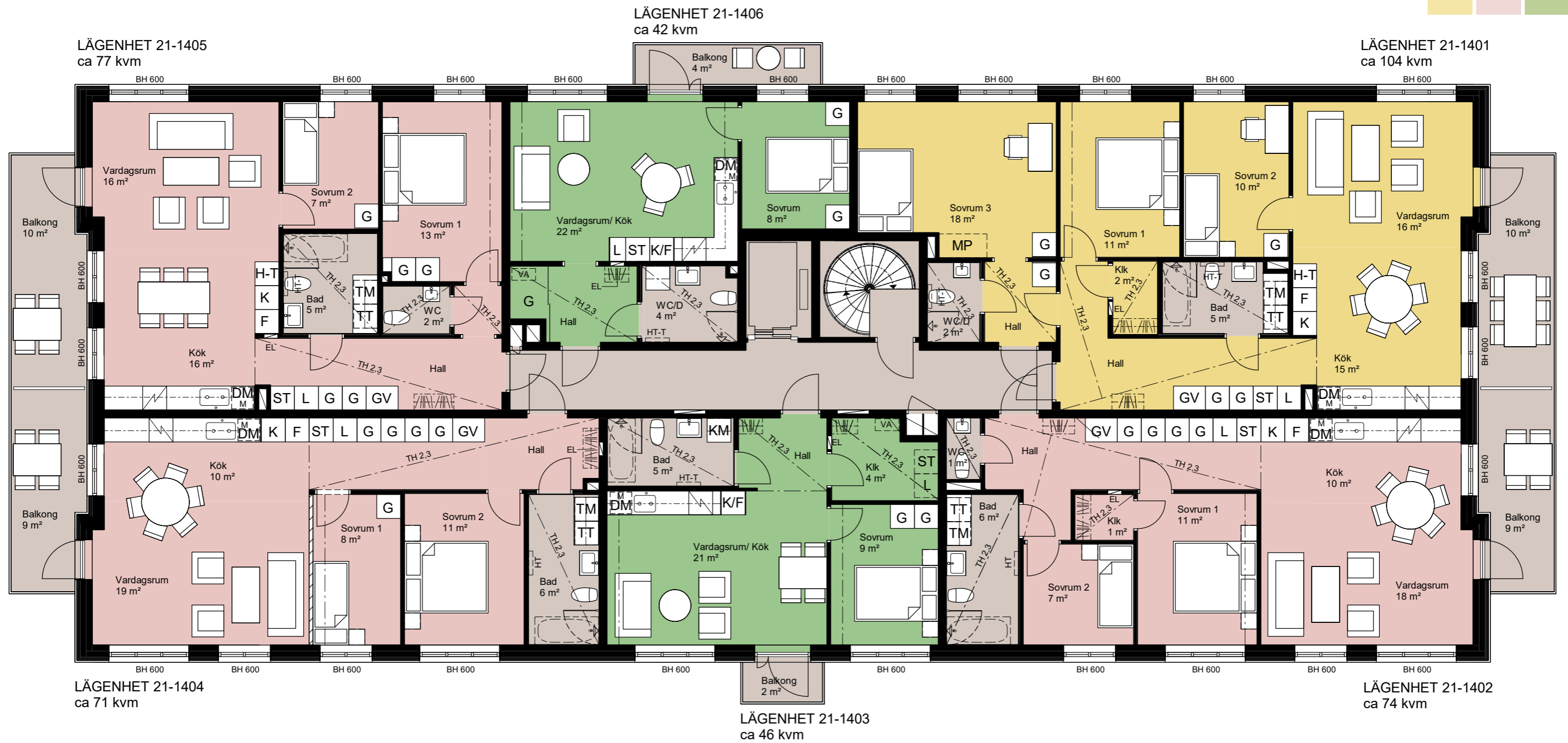



LÄGENHET 21-1504
ca 128 kvm

YTA RÄKNAS EJ I BOA
& RUMSAREA: ca 8m²

YTA RÄKNAS EJ I BOA
& RUMSAREA: ca 7m²

LÄGENHET 21-1501
ca 118 kvm

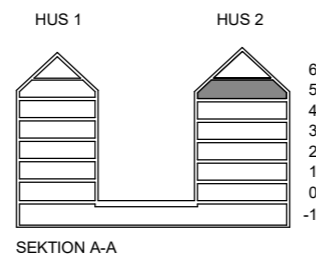
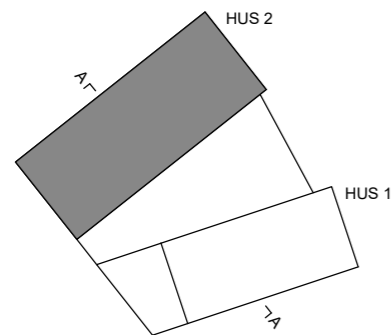
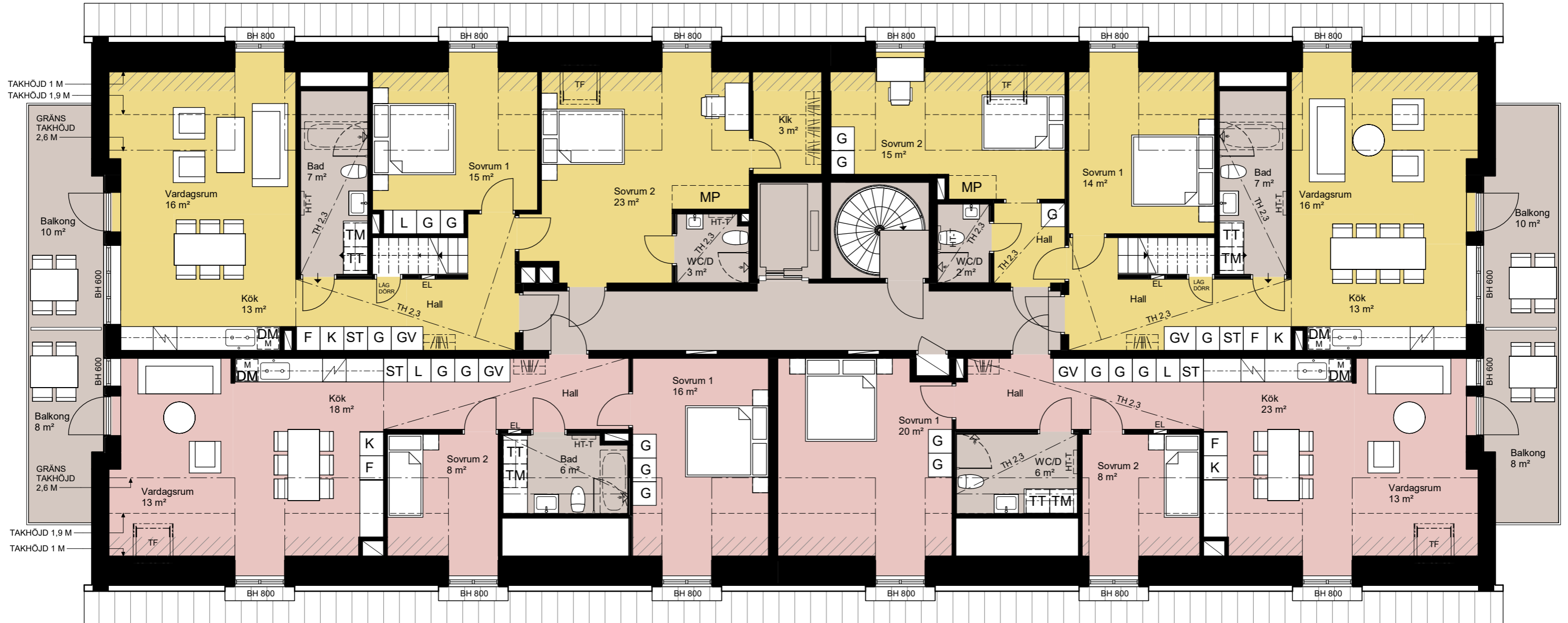

SKALA 1:100

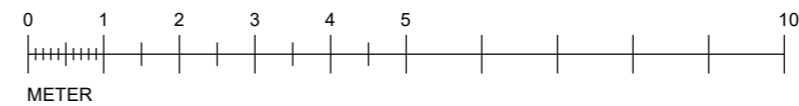

Witte Sundell

LÄGENHET 21-1503
ca 76 kvm

YTA RÄKNAS EJ I BOA
& RUMSAREA: ca 4m²

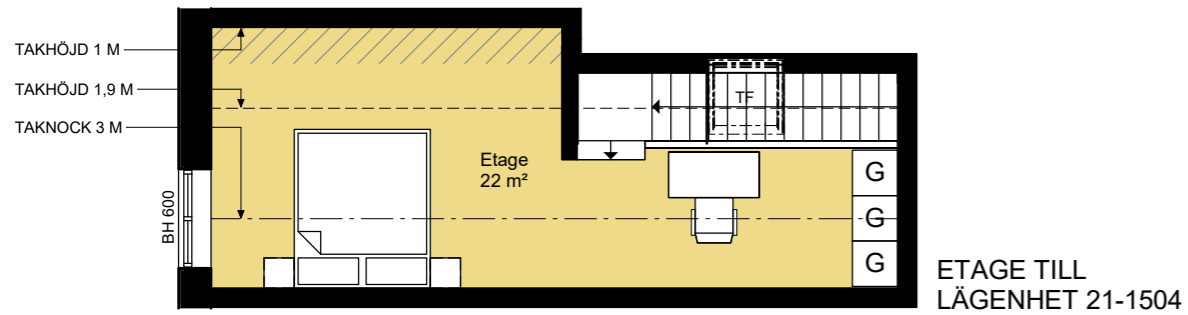

YTA RÄKNAS EJ I BOA
& RUMSAREA: ca 4m²

LÄGENHET 21-1502
ca 80 kvm

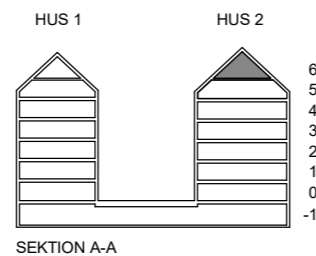
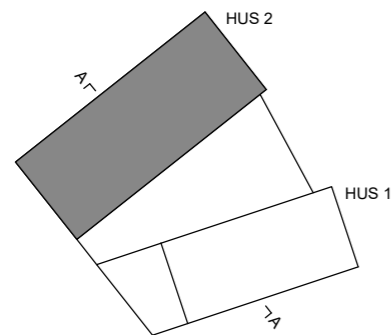
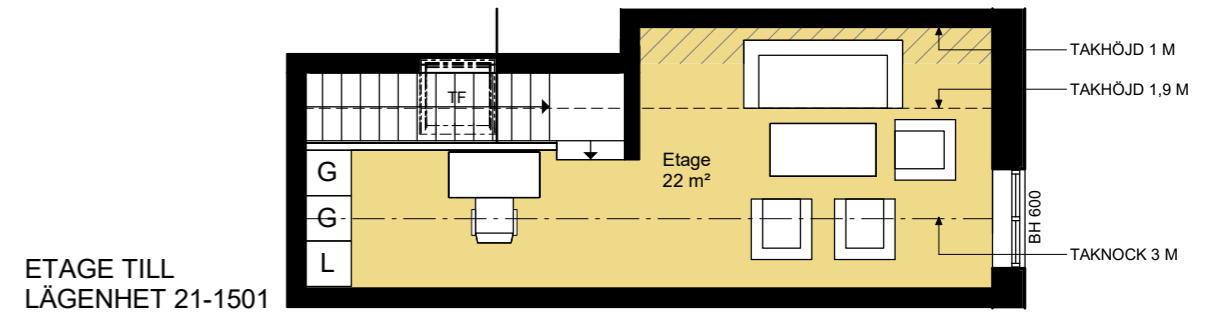

SKALA 1:100

